

COSTRUZIONE MACCHINE AGRICOLE



# Trinciasarmenti mod TLZ Per Trattori da 25 a 45 HP-CV

TRINCIA ARGINI, MULTIUSO PER TRATTORI DI MEDIA E  
BASSA POTENZA

MULCHER MOD. TLZ MULTI-USE VERGE MOWER  
FOR MID- AND LOW-POWER TRACTORS

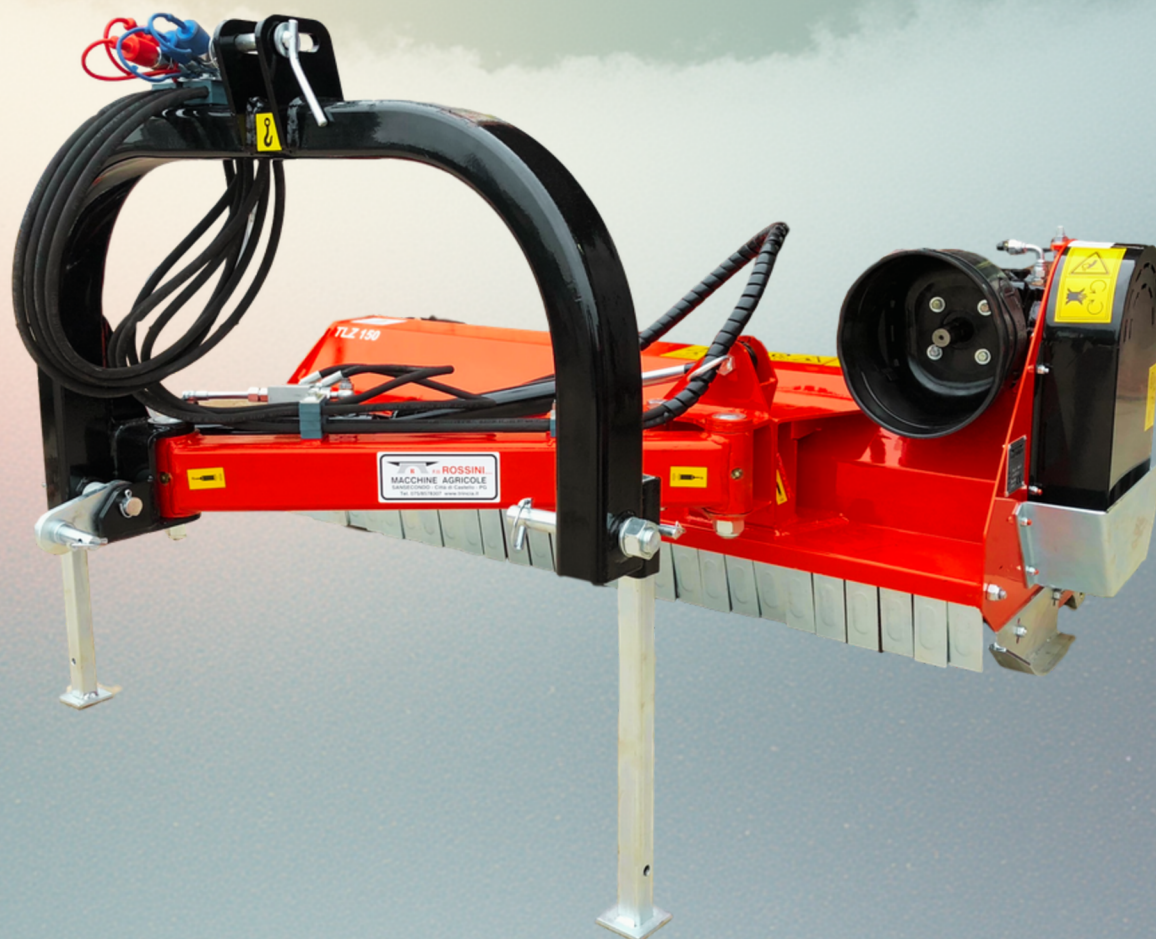

[www.trincia.it](http://www.trincia.it)



# MOD TLZ









**TRINCIASARMENTI MOD.TLZ.** leggero con Inclinazione e spostamento laterali idraulici. **Uso:** Bordi stradali, terrapieni, fossati, potature fino a 5 cm di diametro, erba, ecc .. **Caratteristiche:** ampia area di inclinazione, basso assorbimento di potenza , alta produttività.

**Dotazioni di serie:** Attacco a tre punti, Scatola di Trasmissione con ruota libera , Martelli (o coltelli) , Rullo posteriore regolabile , Slitte Laterali , Giunto cardanico standard , Martinetto per Inclinazione + 90 ° a - 55 ° con Valvola paracadute e vite strozzatrice. Martinetto per spostamento laterale con valvola di blocco e vite strozzatrice. sistema meccanico di sicurezza , piedini di appoggio bandierine di protezione anteriori , protezioni antinfortunistiche a normativa CE .

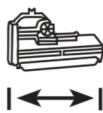

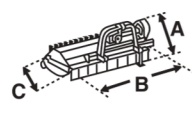
**The model TLZ** is a light shredder with hidraulic inclination and hidraulic side shift. **It can be used** for road edges, ditches, grass and pruning up to 5 cm diameter. **Charachteristic:** wide inclination area, low energy consumption, high productivity.

**Standard equipment:** Three points joint, Freewhell gearbox , Hammers ( or Blades ) , Rear roller , Side slides , Universal Joint , Hidraulic jac for inclination from + 90° to - 55° with chek valve and throttle screw , Jack for side shift with flow regulator and throttle screw - Safety mechanical system , support legs , Front security flaps , Accident prevention protections according to CE

Modello Model							
	cm	PTO	hp - cv	mm	kg	N°	N°
TLZ 130	130	540	25 - 30	910x1460x1330	260	36	18
TLZ 150	150	540	30 - 45	960x1780x1030	280	40	20

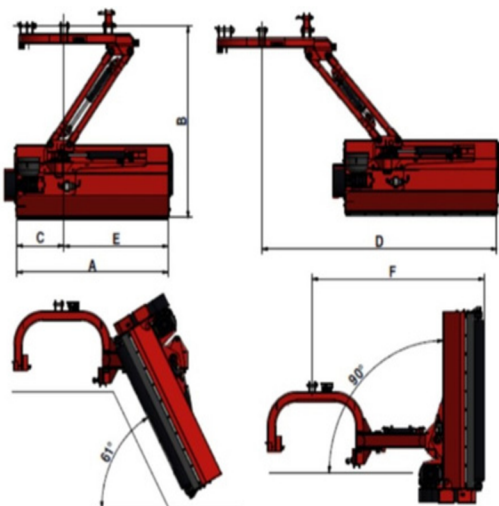

Modello Model	A	B	C	D	E	F
	cm	cm	cm	cm	cm	cm
TLZ 130	130	133	60	180	70	118
TLZ 150	150	133	60	200	90	118